

Panorama® W Series

Ultraline

Multifocal Sensor System, 95 MPe, 30 fps, H.264, H.265, day/night, UWDR, AI/VCA optional, field of view horizontal 180°/360° and vertical 90°, resolution 125 px/m up to 17 m, dome housing



95 MP_e 9 m >250 px/m Identification Distance	95 MP_e 17 m >125 px/m Recognition Distance	95 MP_e 34 m >62 px/m Observation Distance	30 FPS@95 MP _e	AutoCalib	AI / VCA	H265 Encoding	EdgeStorage	Mountera®	Privacy	Security
---	---	--	-------------------------------------	------------------	-----------------	-------------------------	--------------------	------------------	----------------	-----------------

ONVIF | S

The patented **Panorama® Multifocal Sensor System** is a completely new camera technology particularly developed for the extensive **video surveillance of large scale areas**. Enormous expanses and areas are captured in a **completely new resolution quality in real time**. This results in significantly lower infrastructure requirements. Where previously several megapixel cameras would have been necessary, a single Panorama® Multifocal Sensor System is now sufficient.

Panorama® effect

The Panorama® 360° Multifocal Sensor System has been designed with a focus on securing large rooms from a single location. The **innovative combination of high-resolution sensors** offers an outstanding **dynamic range of 130 dB UWDR effectively** and allows the unique **recording of a complete half-space** (half-sphere) in real time. This offers a resolution of more than **125 px/m up to a distance of 17 m**, making it possible to recognize people on an area of 929 sqm. The observation with 62 px/m is even supported on an area of 3,778 sqm, which corresponds to more than half a football field.

Automatic calibration

The innovative lens sensor concept of the Panorama® 360° multifocal sensor system is based on **precisely measured and pre-focused lenses** that are optimally matched to the extremely high-resolution image sensors. The individual lens sensor units are **automatically calibrated** over the network using the **Panorama® AutoCalibration** software.

Video Content Analysis

The optional **Video Content Analysis (VCA)** detects **movements and objects** in the uncompressed image and analyzes them in real-time (depending on the analysis resolution) with highly developed analysis functions such as **Intrusion Detection** or **Line Crossing**. The detected **events** can be used to trigger the recording of a **SMAVIA recording system**. Together with the detected objects and the corresponding metadata, they are stored in a database. This allows the targeted search and evaluation of the recordings by **SMAVIA Viewing Client** with the **SmartFinder** function.

AI support

The latest variants of the multifocal sensor system are equipped with encoder technology that enables **Video Content Analysis supported by AI** (Artificial Intelligence) functions based on neural networks in the camera. This provides a **significantly more powerful object classification**. After a short training phase, the system finally allows an even **more targeted evaluation** of the recordings and a **more effective use** of automatic functions such as **lossless and multiple auto tracking**.

Permanent capturing

The **multifocal sensor system** captures and stores **all areas of the object space** in maximum detail resolution. It does not matter whether the operators in live mode concentrate on a certain area (multiple detail zoom) or whether interesting areas are displayed in detail on the basis of video content analysis (multiple auto tracking). The **Panorama® recordings always contain the entire action** and allow for the evaluation of each incident

Dewarped display

The **sophisticated image processing algorithms of the Panorama® 360° Multifocal Sensor System** allow a geometrically correct and **almost undistorted display of the monitoring area** (linearly scaled in horizontal and vertical direction). This allows the operator a **completely integrated object tracking on the monitor** as well as a unique **overview for the evaluation of finest details** even on long distances.

Further features





- Multifocal sensor system with 4/8 sensors
- Field of view horizontal 180°/360° and vertical 90°
- Video compression H.264, H.265, MJPEG
- Ambient light sensor and removable IR cut filter
- Functions for data protection and data security (GDPR-compliant)
- Weather-proof (IP66) housing with integrated heater
- Housing coating tested for seawater resistance
- Fully compatible with the Mountera® Quick-Lock System

Multifocal Sensor System, 95 MPe, 30 fps, H.264, H.265, day/night, UWDR, AI/VCA optional, field of view horizontal 180°/360° and vertical 90°, resolution 125 px/m up to 17 m, dome housing

Panomera® W8	
005948.410	 <p>Panomera® W8 95/360 DN C Multifocal sensor system, 95 MPe, 30 fps, H.264, H.265, day/night, UWDR, AI/VCA optional, field of view horizontal 360° and vertical 90°, resolution 125 px/m up to 17 m, dome housing, 1000BASE-T Ethernet port for copper cabling</p>

Panomera® W4	
007074.410	 <p>Panomera® W4 45/180 DN C Multifocal sensor system, 45 MPe, 30 fps, H.264, H.265, day/night, UWDR, AI/VCA optional, field of view horizontal 180° and vertical 90°, resolution 125 px/m up to 17 m, dome housing, 1000BASE-T Ethernet port for copper cabling</p>

Licenses	
007075	<p>DLC - AI/VCA for Panomera® S/W 8 Licence to use the Video Content Analysis (VCA) function with AI-supported object classification for a Panomera® S/W 8 system</p>
007076	<p>DLC - AI/VCA for Panomera® S/W 4 Licence to use the Video Content Analysis (VCA) function with AI-supported object classification for a Panomera® S/W 4 system</p>

Accessories	
007054	 <p>Mountera® Box with PSU Mountera® Box with power supply unit, 48 V DC, 5.4 A, 260 W, IP66, white</p>
006978	 <p>Mountera® Box with SRS Edge Mountera® Box with SMAVIA Appliance for recording up to 8 video streams, license for the recording of Panomera® systems with up to 8 sensors included, licenses for access from 2 clients included, power supply unit 48 V DC, 5.4 A, 260 W included, IP66, white, with 2 TB SSD memory</p>
006979	 <p>Mountera® Wall Bracket Mountera® bracket for the installation of camera systems on walls or on a Mountera® Box, Quick-Lock System included, robust aluminium construction, internal cable routing, vandal-resistant, powder-coated, white</p>
006980	 <p>Mountera® Ceiling Bracket Mountera® bracket for installation of camera systems on ceilings, Quick-Lock System included, robust aluminium construction, internal cable routing, vandal-resistant, powder-coated, white</p>

Adapter	
007536	 <p>Mountera® In-Ceiling Adapter W 4/8 Mountera® adapter for the installation of a Panomera® W 4/8 in suspended ceilings, robust steel construction, black (delivery time on request)</p>

Cable Set	
007428	 <p>Mountera® Cable Set C Preassembled cable set for the connection of a camera system to a Mountera® Box, 1x cable seal, 1x cable power supply/grounding, 1x cable network (copper RJ45), each with matching plug, UV-resistant and flexible, length 80 cm</p>

Multifocal Sensor System, 95 MPe, 30 fps, H.264, H.265, day/night, UWDR, AI/VCA optional, field of view horizontal 180°/360° and vertical 90°, resolution 125px/m up to 17m, dome housing

Sensor System	Panorama® W8	Panorama® W4
Number of sensors	8	4
Number of sensor pixels	96 MP	48 MP
Light sensitivity	<0.05lux	
Dynamic range (UWDR)	130 dB (effective)	

Resolution	Panorama® W8	Panorama® W4
Effective resolution (MPe) ¹⁾	Up to 95 MP	Up to 45 MP
Identification distance (≥250 px/m)	Up to 8.6 m (232sqm)	--
Recognition distance (≥125 px/m)	Up to 17 m (929sqm)	Up to 17 m (464sqm)
Observation distance (≥62 px/m)	Up to 34 m (3,778 sqm)	Up to 34 m (1,889 sqm)

Installation Height	Panorama® W8	Panorama® W4
Recommended	5 m	4 m
Permissible	3.5 - 10 m	3.5 - 5.5 m

Field of View	Panorama® W8	Panorama® W4
Horizontal field of view	360° (with 270° mode)	180°
Vertical field of view	90°	90°

Format and Encoding	
Video compression	H.264, H.265, MJPEG
Frame rate	Up to 30 fps at full resolution
Live streaming	Multicast or Unicast (for Viewing Client) Unicast (for recording)

Network and Recording	Panorama® W8	Panorama® W4
Required network bandwidth (nominal, for recording)	128 Mbps ²⁾ 6 Mbps (with Panorama® Streaming Server)	64 Mbps ²⁾ 6 Mbps (with Panorama® Streaming Server)
Recommended network bandwidth	1,000 Mbps	

Functions	
Day/Night switching	Ambient light sensing and removable IR cut filter (ICR)
Black-and-white mode	Automatic (at low light or in night mode)
Digital noise reduction	3D-DNR
Brightness control	Automatic (ALC)
Gain control	Automatic (AGC)
White balance	Automatic (AWB)
Privacy Zone Masking	Hiding/masking of up to 16 protected areas per sensor (up to 100% of the entire image)
Video Content Analysis ³⁾	Intrusion Detection (detection of access to a defined area) Line Crossing (detection of a virtual line crossing) Tamper Detection (detection of manipulations on the camera) Object Classification (classification of objects with AI support) Face Detection (detection of faces) ⁴⁾

Protocols	
Ethernet protocols	IPv4 (ARP, ICMP, IGMPv2/IGMPv3), UDP, TCP, LLDP, CDP (v1,v2), DSCP (QoS), DNS, DHCP, NTP, HTTP/HTTPS ⁵⁾ , RTSP/RTP/RTCP, SNMP (v1, v2c, v3)
Ethernet protocols in preparation	IPv6 (NDP, ICMPv6, MLDv1/MLDv2, SLAAC, RDNSS), UDPv6, TCPv6, DNSv6, DHCPv6, LDAP
Communication protocols	DaVid, DaVidS, ONVIF Profile S, SNMP (v1, v2c, v3)
Security	HTTPS ⁵⁾ encryption, SSL/TLS ⁵⁾ 1.2 (AES), network access control according to IEEE 802.1X ⁵⁾

1) Effective resolution (MPe) compared to a conventional 360° fisheye camera.

2) This value is based on the encoding of each sensor with 16Mbps and the use of the recording system as a proxy for the live view.

3) Optional and depending on the load of the CPU.

4) The function detects the presence of a face (Face Detection). The analysis of visible features and the link to person data (Face Recognition) are not supported.

5) This product includes software developed by the OpenSSL Project for use in the OpenSSL Toolkit (<http://www.openssl.org>) and cryptographic software written by Eric Young (ey@cryptsoft.com).

Multifocal Sensor System, 95 MPe, 30 fps, H.264, H.265, day/night, UWDR, AI/VCA optional, field of view horizontal 180°/360° and vertical 90°, resolution 125px/m up to 17m, dome housing

Connections	
Ethernet 1	Telegärtner STX V4 socket with STX RJ45 coupling Cat.6 for 1000BASE-T (1,000 Mbps)
Ethernet 2	Telegärtner STX V4 socket with STX RJ45 coupling Cat.6 for 100BASE-TX (100 Mbps, service port)
Power IN	HARTING connector (5-pole)
Electrical Data	
Voltage supply	Camera: 48V DC ±5% Heater: 48V DC ±5%
Power consumption	Camera: Max. 80W Heater: Max. 60W
Mechanical Data	
Dimensions (W × H × D)	Approx. 245 × 254 × 245 mm (9.6 × 10.0 × 9.6 inches)
Weight	Approx. 10 kg (22 lb)
Material	Aluminium
Processing	Chromated
Finish	Powder coating, tested for seawater resistance according to DIN EN 60068-2
Color	Signal white (RAL 9003 ⁶⁾), housing Signal black (RAL 9004 ⁶⁾), sensor unit
Adjustment	Stepless alignment on 3-axes up to ±5°
IK protection	IK10
IP rating	IP66
Environmental Conditions	
Installation sites	Indoor and outdoor
Operating temperature	-40 °C to +55 °C (-40°F to +131°F) (minimum start-up temperature: -30 °C (-22°F)) Heater On: < +10 °C (+50°F) Heater Off: > +10 °C (+50°F)
Relative humidity	0% – 90% RH, non-condensing
Miscellaneous	
Ambient light sensor	Integrated
Removable IR-cut filter	Integrated
Local memory	50 MB RAM memory per sensor
Configuration and live video	Via web browser (all major platforms), SMAVIA Recording Server Software and PService3 (with Panomera® AutoCalibration add-on)
Languages	German, English,
Programming interface	Open platform for integration into 3rd party systems using API and ActiveX ⁷⁾
ONVIF compliance	Profile S
GDPR compliance	Supported
Approvals/Certifications	
Type	CE, FCC, RCM, DIN EN 50130-4 compliant

6) The color of the powder coating may differ slightly from the RAL color indicated. This is due to production and does not constitute a defect.

7) ActiveX is a trademark or registered trademark of Microsoft Corporation headquartered in Redmond, Washington, USA

Panamera® W Series

Ultraline

Multifocal Sensor System, 95 MPe, 30 fps, H.264, H.265, day/night, UWDR, AI/VCA optional, field of view horizontal 180°/360° and vertical 90°, resolution 125px/m up to 17m, dome housing

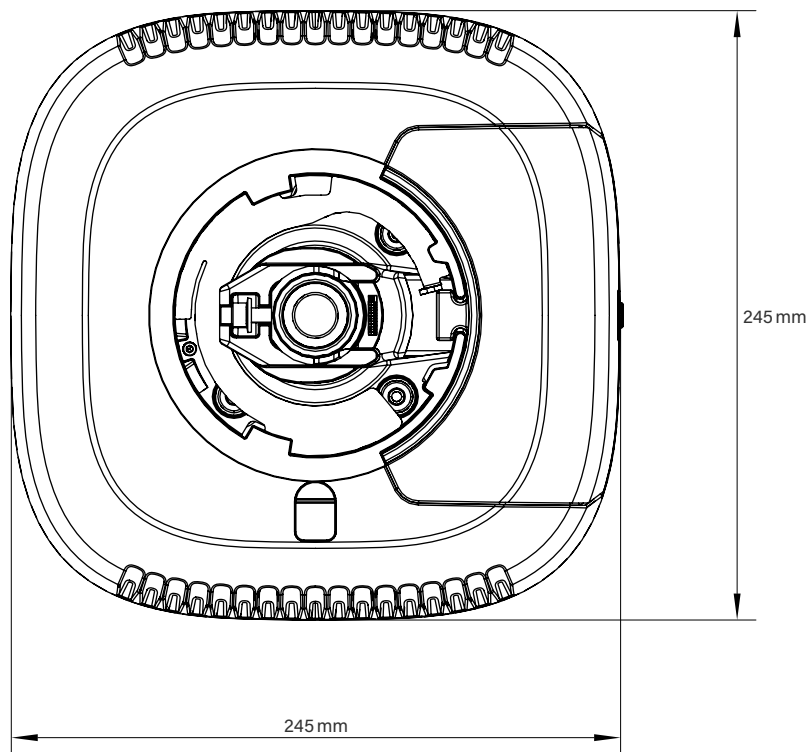
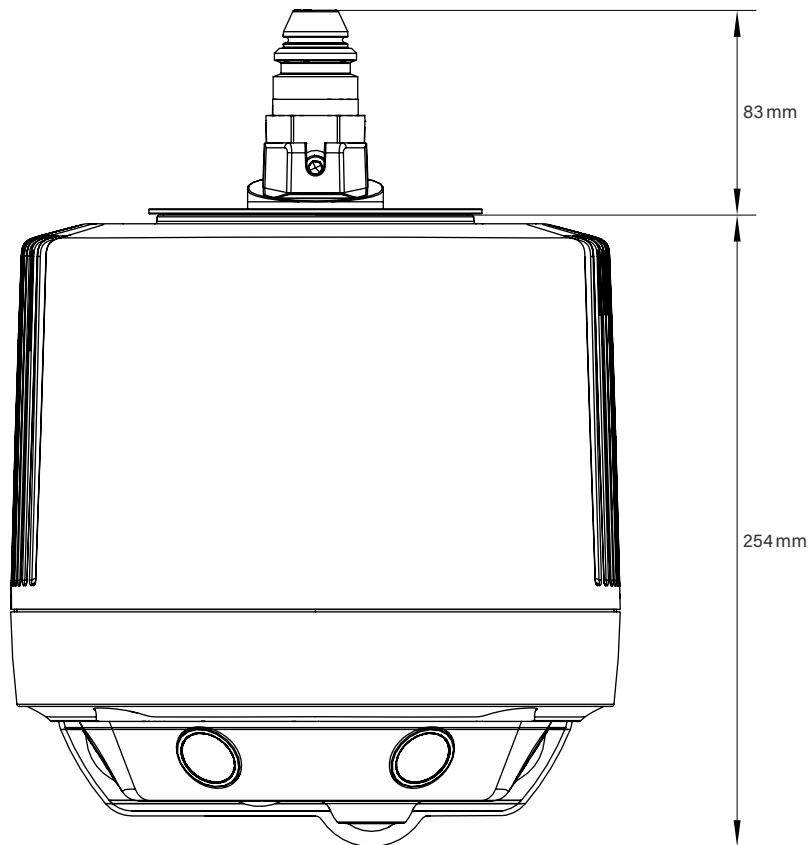

Dallmeier electronic GmbH & Co.KG | Bahnhofstr. 16, 93047 Regensburg, Germany | +49 941 8700-0 | dallmeier.com

All trademarks identified by * are registered trademarks of Dallmeier electronic GmbH & Co.KG.

Third-party trademarks are named for information purposes only. Dallmeier electronic respects the intellectual property of third parties and always attempts to ensure the complete identification of third-party trademarks and indication of the respective holder of rights. In case that protected rights are not indicated separately, this circumstance is no reason to assume that the respective trademark is unprotected.

Specifications subject to change without notice. Errors and misprints excepted. Pictures may differ from the actual product.



See more.